









Teile / Parts List

1	2	3	4	5	6	A	B	C
								
M8*50mm 2 PCS	M8*35mm 1 PC	M8*80mm 2 PCS	M3.5*50mm 2 PCS	Ø8*38mm 2 PCS	1 PC	D22*50cm 1PC	D22*60cm 2 PCS	1 PC

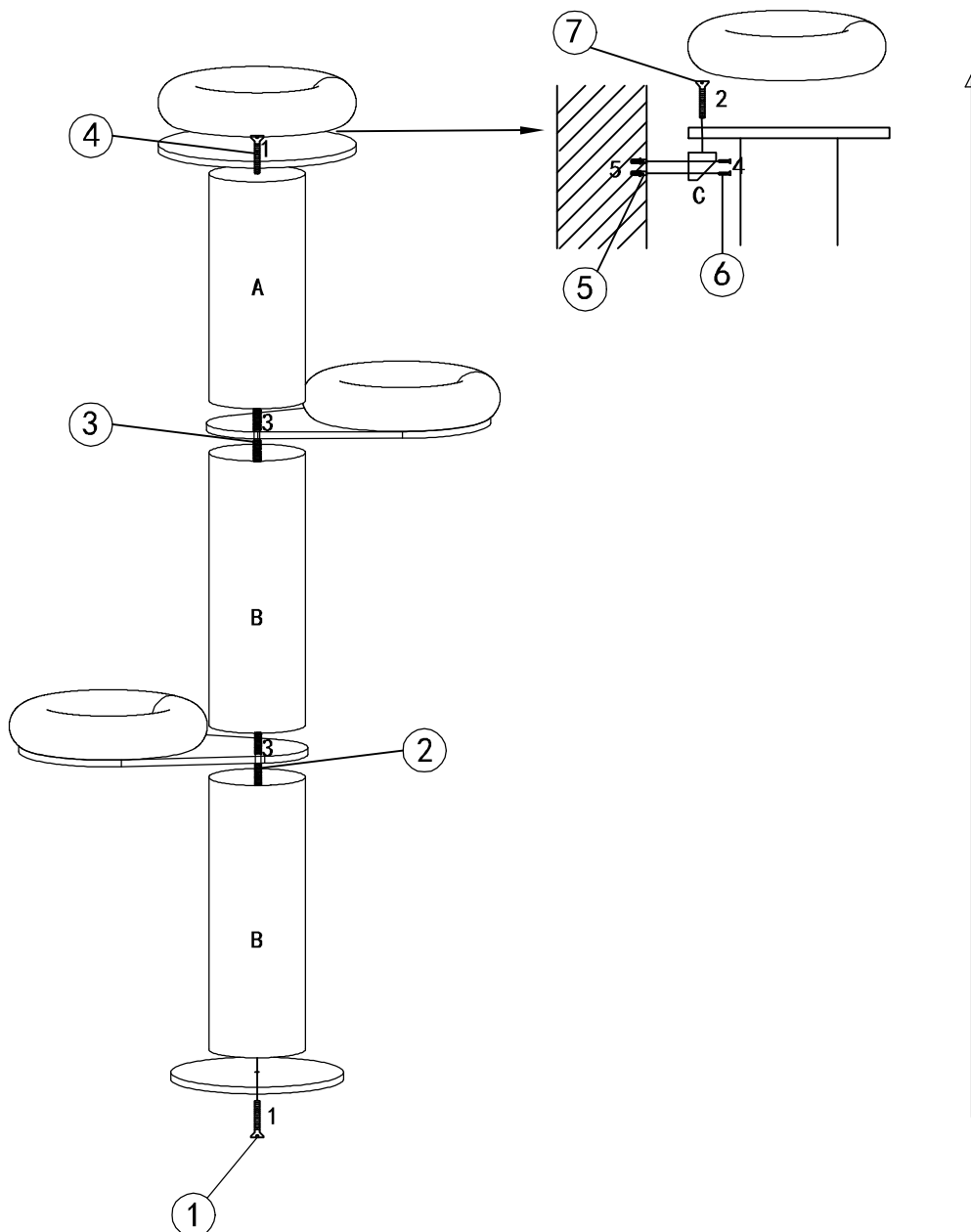

Bitte halten Sie die Reihenfolge der Arbeitsschritte 1,2,3,... von der Skizze ein.
 Pls follow the sequence of the workflow 1,2,3,... as you can see on the draft.