







## Teile/Parts List

1	2	3	4	A	B
					
M8*45mm 2 PCS	M8*60mm 5 PCS	M8*80mm 1 PC	1 PC	D9.0*13CM 2 PCS	D9.0*26CM 2 PCS

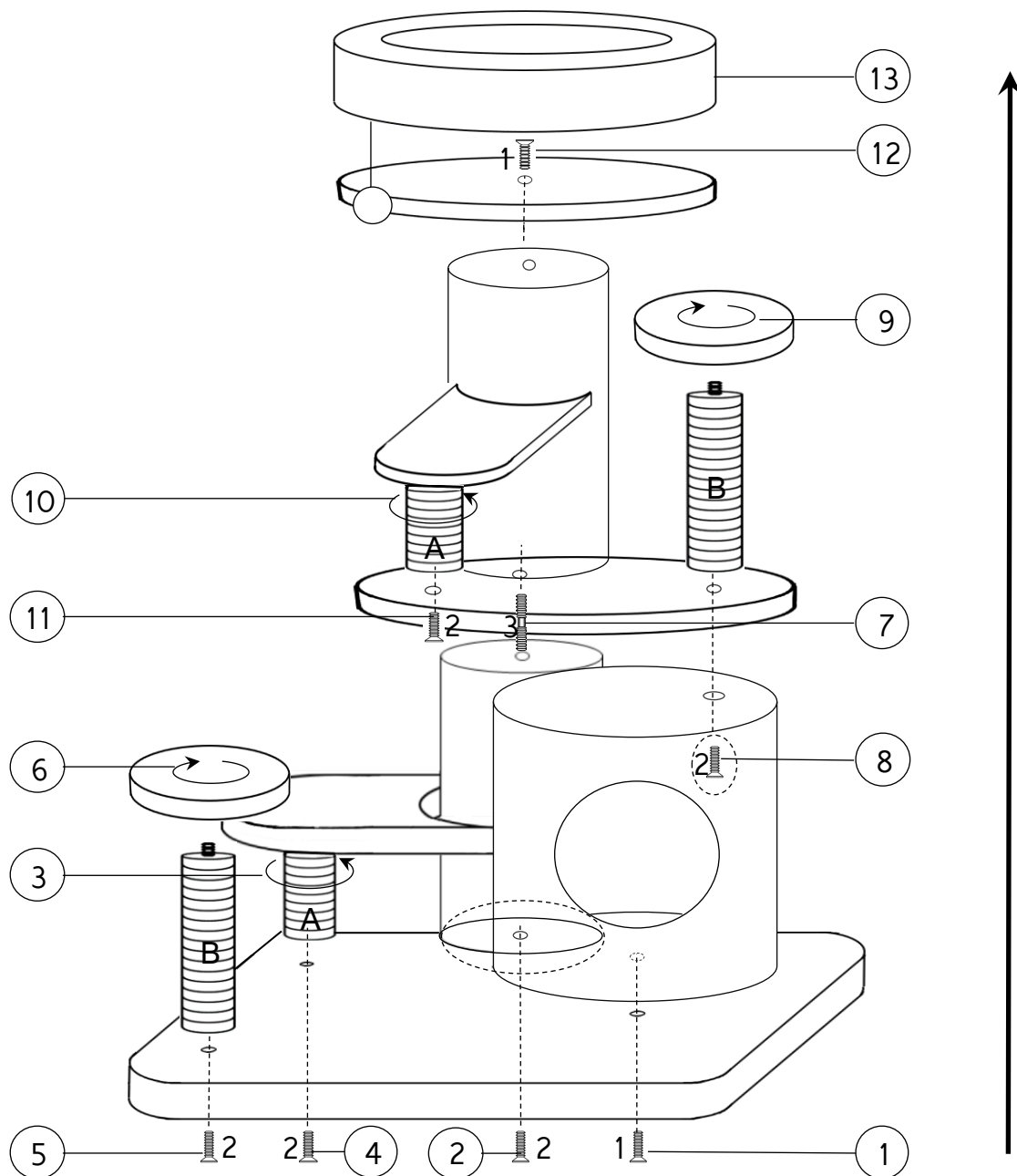

Bitte halten Sie die Reihenfolge der Arbeitsschritte 1,2,3,... von der Skizze ein.

Pls follow the sequence of the workflow 1,2,3,... as you can see on the draft.