











Teile / Parts List

1	2	3	4	5	6	7	A	B	C
									
m8*50mm 4 PCS	m8*50mm 16 PCS	m8*80mm 1 PC					D9*40cm 6 PCS	D6*33cm 1 PC	D6*25cm 4 PCS

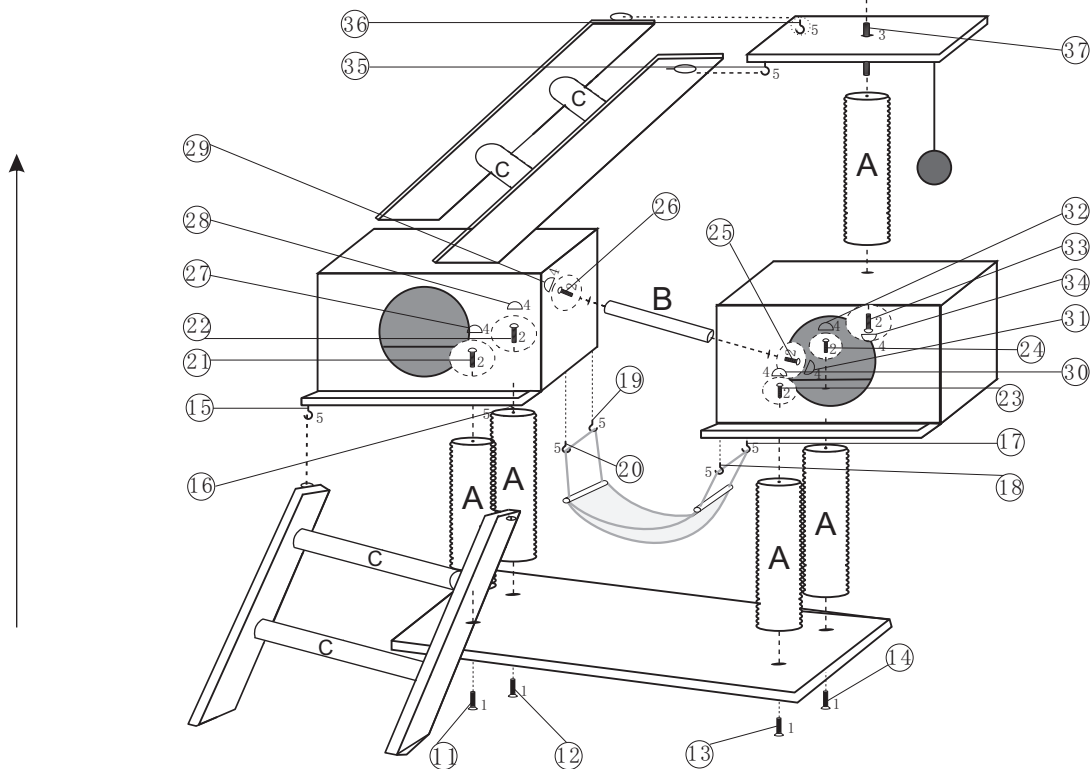
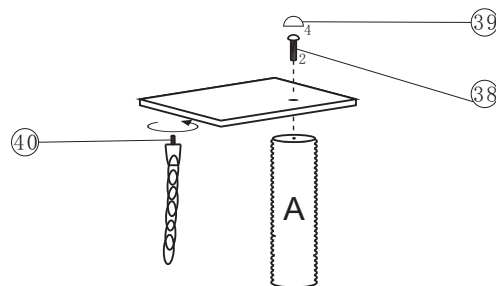
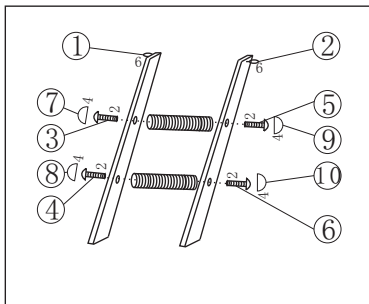

Bitte halten Sie die Reihenfolge der Arbeitsschritte 1, 2, 3, ... von der Skizze ein.
Pls follow the sequence of the workflow 1, 2, 3, ... as you can see on the draft.