









Teile / Parts List

1	2	3	4	5	A	B	C
							
M8*50mm 7 PCS	M8*60mm 1 PC	M8*70mm 2 PCS	1 PC	3 PCS	D9.0*27cm 2PCS	D9.0*56cm 3 PCS	D8.5*35cm 2 PCS

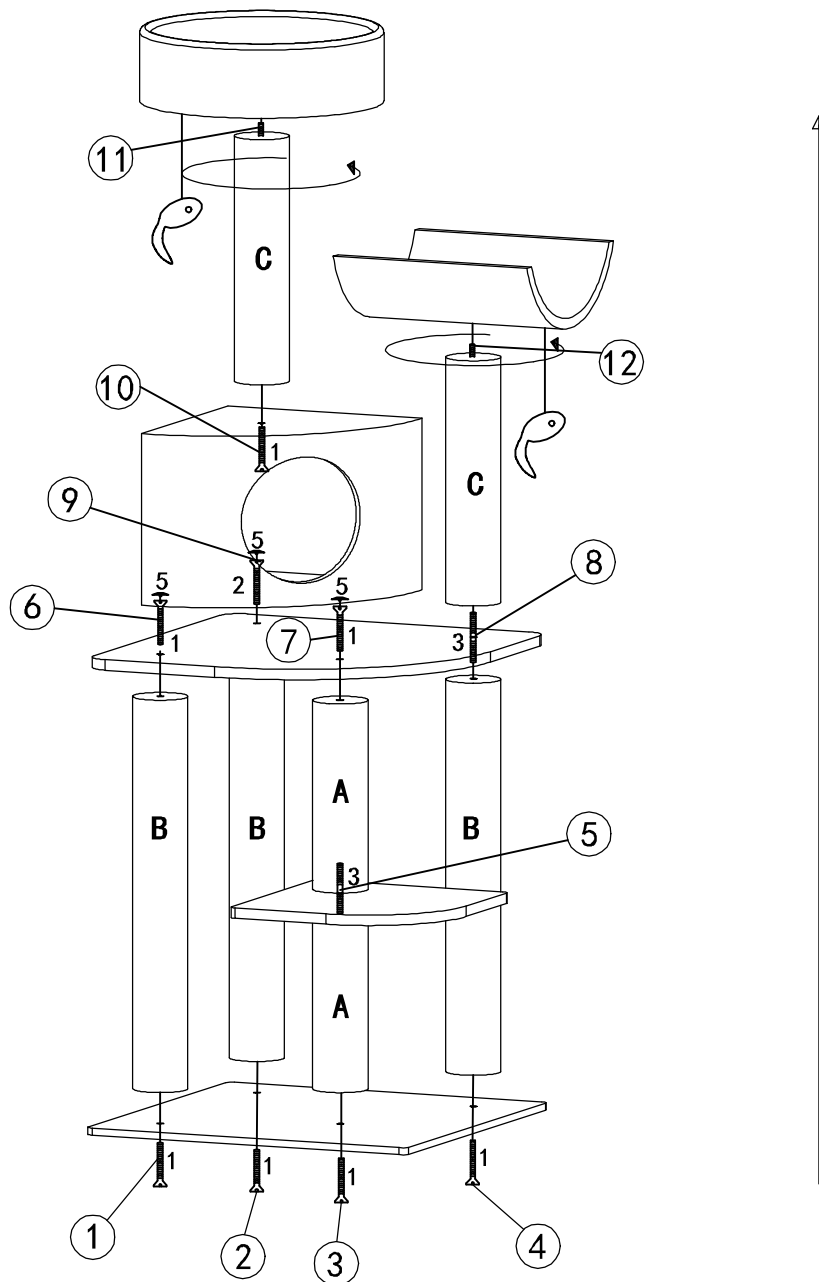

Bitte halten Sie die Reihenfolge der Arbeitsschritte 1,2,3,... von der Skizze ein.
 Pls follow the sequence of the workflow 1,2,3,... as you can see on the draft.