









Teile/Parts List

1	2	3	4	5	6	A	B	C
								
M8*60mm 3PCS	M8*50mm 1PC	M8*24mm 1PC	M8*18mm 2PCS	M8*80mm 5PCS	1PC	D9*50cm 5PCS	D9*30cm 2PCS	D9*18cm 1PC

STEP 1

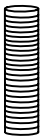
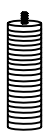

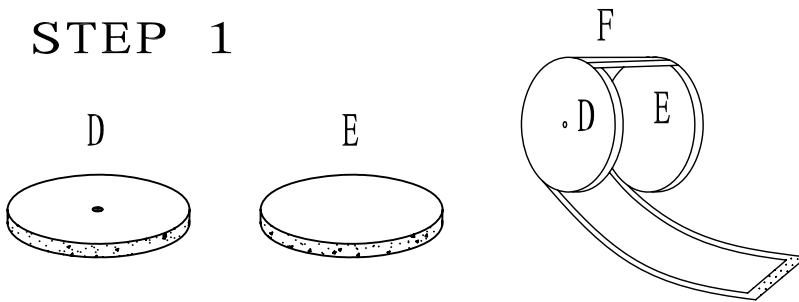
STEP 2

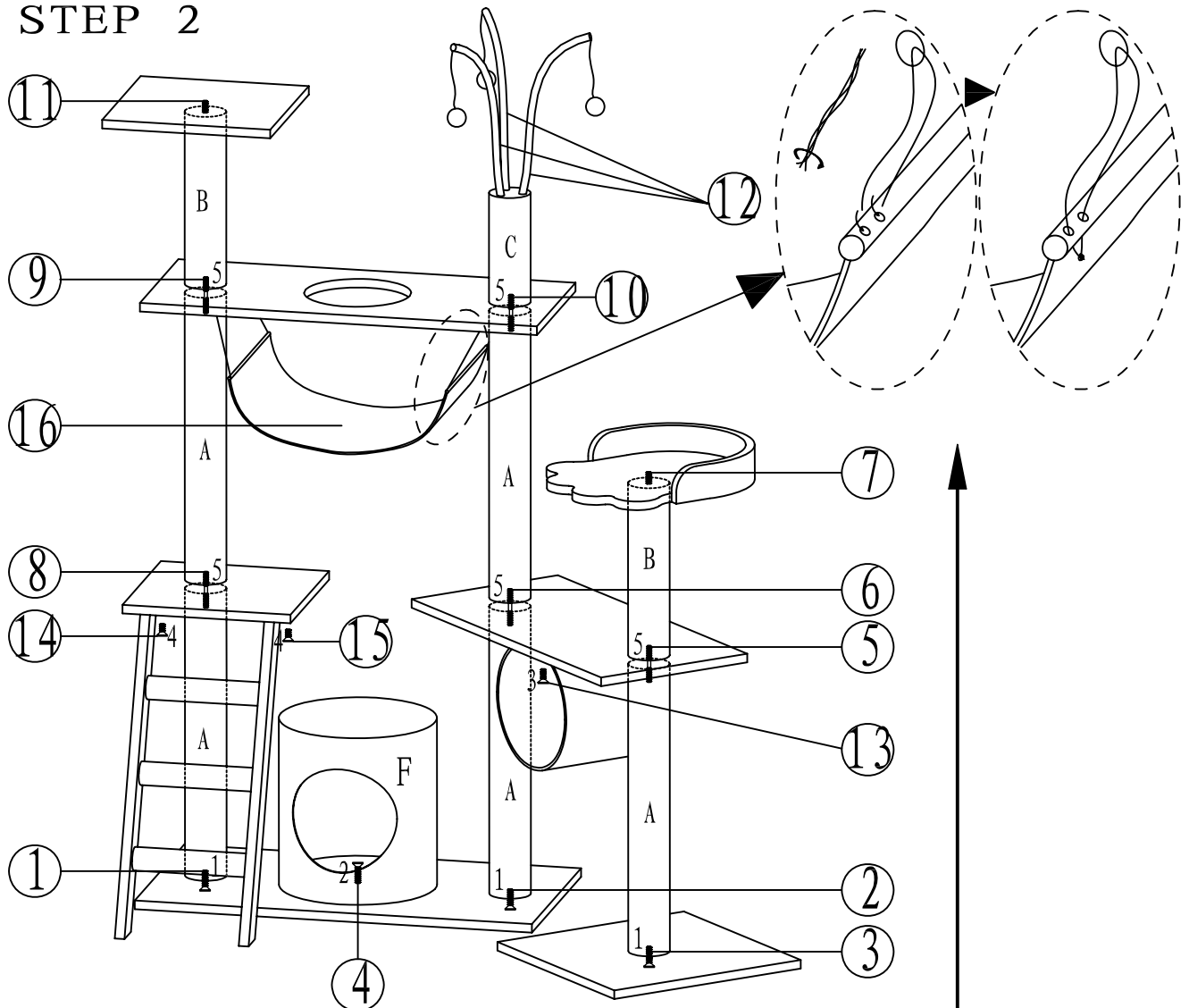

Bitte halten Sie die Reihenfolge der Arbeitsschritte 1,2,3,.... von der Skizze ein.
 Pls follow the sequence of the workflow 1,2,3,.... as you can see on the draft.